

## Trajectory-Aware Vertical Handoff Protocol Between WiMAX and 3GPP Networks

<sup>1</sup>Thazin Ei and <sup>2</sup>Wang Furong

<sup>1</sup>Friendship Apartment,

<sup>2</sup>Communication Software Center (E.I.E Dept.), Huazhong University of Science and Technology,  
Wuhan, Hubei, 430074, People's Republic of China

---

**Abstract:** A Trajectory-Aware Vertical Handoff (TAVH) protocol which provides seamless handoff between Worldwide Interoperability for Microwave Access (WiMAX) and Third Generation Partnership Project (3GPP) evolved packet networks is proposed. To reach this approach, TAVH calculates the position, velocity, handoff signaling delay and RSS of MT and each and every data is taken in account in handoff decision. Moreover, simple network architecture for WiMAX and 3GPP interworking based on proxy mobile IPv-6 is presented. Then, the operation of TAVH protocol is explained in detail. Simulation is provided by using random motion model which is very realistic in order to show that the proposed TAVH method consistently outperforms the other methods in almost every output parameter of this simulation.

**Key words:** 3GPP, WiMAX, Proxy Mobile IPv-6, seamless handoff

---

### INTRODUCTION

Generally, handoff protocol types could be divided into four: network controlled handoff (NCHO), mobile assisted handoff (MAHO), soft handoff (SHO) and mobile controlled handoff (MCHO). NCHO minimizes the duration of handoff since the network makes a handoff decision. In MAHO technology, measurements are made by MT and decision is made by MSC. In fact, SHO is a special case of MAHO and it is a make before break connection. In MCHO, MT has absolutely responsible for all control of handoff process. On the other hand, not only the RSS measurements but also handoff decision is made by MT. Nowadays, since 4G access technologies emerges as a result of development and deployment of evolved 2G/3G infrastructures, handoff protocols which can support seamless handoff between these heterogeneous networks are crucial. To approach this goal, researchers have proposed many literature works by considering many handoff criteria. Among from them, velocity information is a critical one, especially for overlay systems and velocity adaptive algorithms. In the overlay systems (Xiao *et al.*, 2001), to increase the system capacity as much as possible network operators assign slow-moving users to micro/picocells and fast-moving users to macrocells by using velocity information. It may also decrease the number of dropped calls in these overlay systems. Moreover, in cellular systems, arrival time can be predicted by velocity information and position

information of MT and then, communication channels for handoff calls can be reserved for achievement successful handoff (Mohanty, 2005). Many researchers have proposed that velocity information has very significant effect for handoff decision (Bhattacharyal *et al.*, 2008; Kim *et al.*, 2008; Cha *et al.*, 2008). Authors have presented an adaptive handoff-relieving scheduling algorithm (Hui *et al.*, 2007). This algorithm decreases the handoff over-head and completes the data transmission with shorter time by using the on-line channel condition and velocity information together. Therefore, velocity information should be taken into consideration in handoff decision making to be more efficient since handoff characteristics greatly depend on the velocity of mobile users. So, here, the important challenges become how to make accurate prediction of speed of the mobile users and how to compute precise direction for this movement. To approach these challenges, the velocity of MT can be divided into two parts as radial velocity and tangential velocity. Tangential velocity has no effect on signal strength and handoff trigger (Liu *et al.*, 2008) since only radial velocity has serious effect on the performance of handoff. Thus, for more accurate and better handoff management only radial velocity is specifically considered in this proposed TAVH protocol.

In handoff management, not only velocity information but also location information plays in a vital role. The tradeoff between using location information sufficiently and improving handoff performance distinctly

is the one of most important challenges for hand-off management in next generation heterogeneous wireless networks. The location information has been utilized to assign the hysteresis threshold adaptively for the improvement of handoff performance (Wang *et al.*, 2001). Authors have reported an improved handover algorithm which reduces the number of unnecessary handover by using location and velocity information estimated from GSM measurement data of different signal strengths at MT received from base stations (Lin *et al.*, 2005; Juang *et al.*, 2005). Bing *et al.* (2003) have proposed a vertical handover initiation model for WLAN and UMTS integrated networks based on the received signal strength (RSS) and distance. From above literature works we can see that location information is also having great effect or influence upon handoff management. Therefore, location information should be taken into account in order to provide seamless handoff between heterogeneous wireless networks. Another important factor to determine handoff is, of course, the signal strength of the base station at individual point. Handoff should be started when the receiving signal strength of MT is lower than the threshold value. But because of noise, the signal strength used to fluctuate a lot and cause a lot of false trigger for the MN to handoff and hence Ping-pong handoffs are occurred. Ping-pong handoffs are notorious for increasing signaling load and so various approaches have been proposed to avoid these handoffs. Some of the successful approaches include dwelling timer method, hysteresis margin method, methods applying average rectangular window on RSS values and application of least square line on RSS values. Among these methods, we have found that least square line method (Kim *et al.*, 2007) is very promising in reducing Ping-Pong handoff.

Based upon all of beforehand information, TAVH protocol which provides seamless handoff between WiMAX and 3GPP evolved packet networks is proposed in this study. TAVH protocol comprises of neighbor discovery unit, handoff signaling delay estimation unit, speed and distance calculation unit, RSS measurement unit, handoff trigger unit and handoff execution unit. In order to fully understand how the proposed TAVH protocol works, the operation of TAVH protocol is presented. Since proxy mobile IPv-6 (PMIPv-6) is used for supporting Inter mobility management between these networks, the operation of MIPv-6 is explained in detail. Moreover, simple network architecture for WiMAX and 3GPP interworking based on the architecture standardized by 3GPP in the context of Rel-8 specifications is presented with detail explanation. Then simulation is done for performance analysis and comparison of proposed TAVH protocol.

## PROXY MOBILE IPV-6 (PMIPv-6)

One of network based protocols, PMIPv-6 is used so that mobile nodes (MNs) to continue IP sessions without mobility management operations since network can track the movements of the host and initiate the required mobility signaling on its behalf (Diab *et al.*, 2008). Proxy MIPv-6 is a network-based IP which can support mobility management to mobile node so that MN does not need to serve any IP mobility related signaling. PMIPv-6 works with mobility entities in the network including Local Mobility Anchor (LMA) and the Mobile Access Gateway (MAG). LMA is not only the home agent for the mobile node in a Proxy Mobile IPv6 domain but also topological anchor point with its home network since it handles binding state of the UE. MAG handles mobility management concern with tracking of UE's movement which attaches with its access link, as well as, signaling the mobile node's local mobility anchor since it is a gate way. How PMIPv-6 works for handoff processing is explained as demonstrated in Fig. 1. Firstly, MN has to detach with its previous mobility access gateway (p-MAG) since it can not be reached more. So, it starts detached event by informing LMA to remove the binding and routing state for that mobile node. After it receives back acknowledgment message from LMA, MN can start attachment with new mobility access gateway (n-MAG). Thus, MN sends solicitation message to n-MAG in order to bind it proxy new care of address with LMA. When LMA accepts this proxy binding update message (PBU), it allocates mobile node's home network prefix (es) (HNP) and set up binding cache entry (BCE) as well as it tunnel to n-MAG. After that, n-MAG sends router advertisement message to MN to retain home address (HoA) delivered from home network prefix (es).

## INTERWORKING ARCHITECTURE OF WiMAX AND 3GPP EVOLVED PACKET CORE

This core network architecture for WiMAX and 3GPP interworking is intended to support the high-throughput and low latency with its simplicity. To reach this approach, we present the network architecture for WiMAX and 3GPP interworking as shown in Fig. 2. This interworking architecture is greatly based on the architecture standardized by 3GPP in the context of Rel-8 specifications (3GPP TS 23.401, 2008; 3GPP TS 23.402, 2008). We assume that UE can access 3GPP radio accesses as well as non-3GPP, WiMAX technology. But, UE will access only one service at the same time. On the other hand, hard handoff is performed when UE needs to switch from WiMAX to 3GPP radio technologies or the reverse requirement of that one. We explain detail the

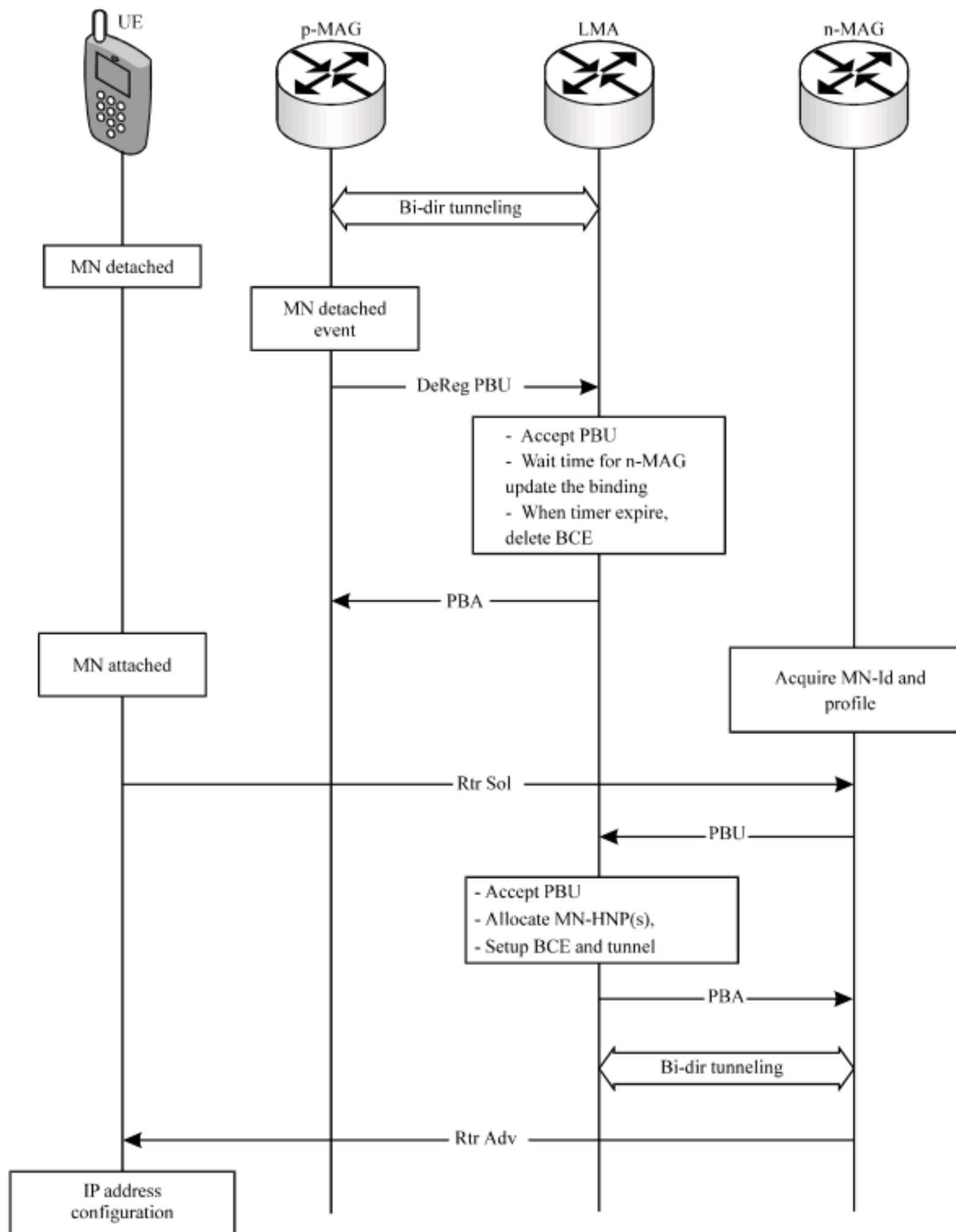

Fig. 1: Mobile node handoff signaling call flow

simple interworking architecture between 3GPP radio technologies and WiMAX service which we use so that the readers fully understand how the proposed TAVH protocol works.

The 3GPP is a collaborative agreement between standards development organizations and other bodies for the production of a complete set of globally applicable technical specifications. The core network architecture of 3GPP's future Long Term Evolution (LTE) wireless communication standard is System Architecture Evolution (SAE). And, the core network component of SAE is

Evolved Packet Core (EPC). Evolved packet core (EPC) is intended to support and integrate a new all-IP core network not only for 3GPP radio technologies such as Evolved Universal Terrestrial Radio Access Network (E-UTRAN), UMTS Terrestrial Radio Access Network (UTRAN), GSM/EDGE Radio Access Network (GERAN), but also for non-3GPP access such as wireless local area network (WLAN) and WiMAX networks. EPC comprises with Mobility Management Entity (MME), Serving Gateway (S-GW) and PDN Gateway (P-GW). MME manages and stores the UE control plane context,

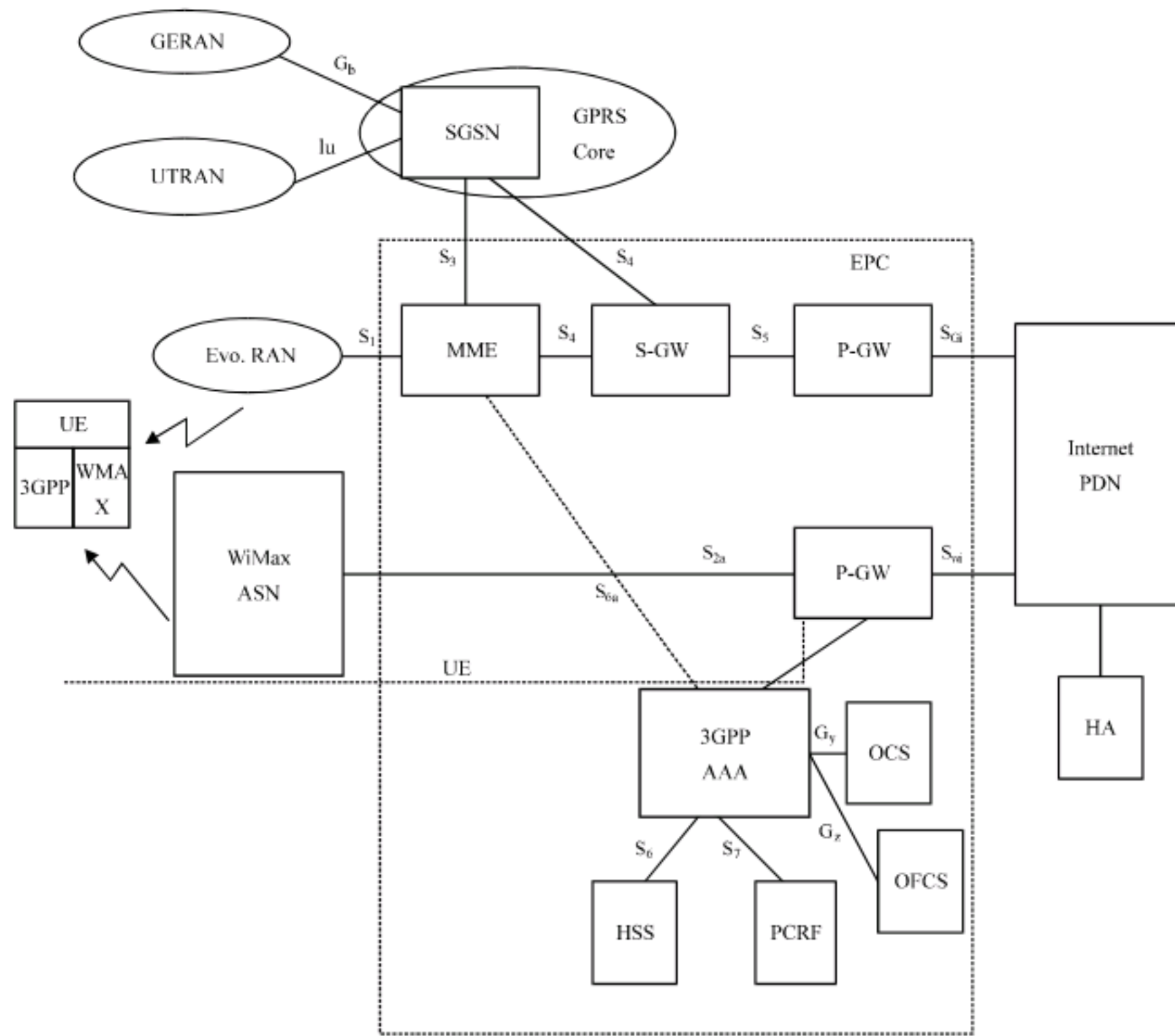

Fig. 2: Network architecture for WiMAX and 3GPP interworking

generates temporary Id, UE authentication, authorization of Public Land Mobile Network (PLMN), mobility management. S-GW is a gate way for all 3GPP-specific access technologies as well as it is a mobility anchor between 2G/3G and LTE. On the other hand, it serves like a gate way between serving GPRS support node (SGSN) and the PDN gateway (P-GW). User and bearer information exchange for inter 3GPP access system mobility is done by through S<sub>4</sub> interface which provides the user plane with related control and mobility support between GPRS Core and the 3GPP Anchor and is based on Gn reference point as defined between SGSN and GGSN. P-GW is a common gate way all data paths delivered from 3GPP services or WiMAX service or WLAN service and hence it handles many mobility management including packet filtering, interception, charging and IP address allocation, etc.

Worldwide Interoperability for Microwave Access (WiMAX) is an emerging fixed broadband wireless technology so that it can provide broadband wireless

access (BWA) up to 30 miles (50 km) for fixed stations and 3-10 miles (5-15 km) for mobile stations (Zhang and Hsiao-Hwa, 2008). Here, in the proposed 3GPP radio technologies and WiMAX interworking architecture, WiMAX is based on IEEE 802.16e specification, the mobile version of WiMAX. A Mobile WiMAX network comprises of three major components: mobile stations (MSs), network access providers (NAPs) and network service providers (NSPs). MS establishes user equipment interface with its home authentication, authorization and accounting (AAA) server so that authentication and authorization can be served. A NAP is an operator for access networks and hence it comprises of many Access Services Networks (ASNs) which provide WiMAX access services for the UE. The ASN comprises of base stations (BSs) which are controlled by one or more ASN-gateways (ASN-GWs). ASN-GW is not only for this purpose, but also it serves as a gateway between an ASN and a connectivity services network (CSN). So, control function such as AAA, policy enforcement and mobility

management between ASNs and CSNs are served through this interface.

The WiMAX is connected to 3GPP Evolved Packet Core via the P-GW and to the 3GPP Authentication, Authorization, Accounting (AAA) server for the WiMAX authentication process. Detail authentication process of WiMAX is served by using the EAP framework. The policy and charging (PCC) can be used for authorization purpose. It is designed to allow policy and charging rules function (PCRF) (3GPP TS 23.203, 2008) so that the QoS and charging authorization can be supported.

### OPERATION OF TAVH PROTOCOL

As demonstrated in Fig. 3, TAVH protocol management's module comprises of neighbor discovery unit, handoff signaling delay estimation unit, speed calculation unit and distance calculation unit by the data generated from global position system (GPS) (Kaplan and Hegarty, 2006), RSS measurement unit and least square line (LSL) and handoff trigger unit and handoff execution unit. We present the whole operation of proposed protocol as the following steps.

**Neighbor discovery unit:** While the Mobile Terminal (MT) moves across the networks, it learns about neighbor BSs using neighbor discovery unit. As MT roams, it discovers which preferred services are becoming available so that it can switch. For instance, MT is currently serviced by 3-GPP access but once WLAN or WiMAX which can offer higher bandwidth, lower cost and better quality than 3-GPP are available, it will switch to WLAN or WiMAX networks to enjoy by the preferred

services. Neighbor discovery can be done possibly with two ways: by MT alone without any assisted or by network-assisted. If neighbor discovery is performed by MT alone, this method is very simple and does not need any modifications in the network. However, battery power consumption may be rapidly high since nowadays user demands are increasing day by day, or, MT can not get enough information about neighbor BSs, or, two receivers may be needed (one is for discovery and another is for ongoing sessions). The main advantage of using network-assisted is neighbor discovery unit can get information of neighbor BSs easily by having each cell in the network broadcast a list of neighbor cells. But, it needs to be sure that neighbor discovery unit can collect information of each neighbor BSs without any data loss since one receiver MT may be used in this method. Moreover, special functional entity proposed (3GPP TS 23.402, 2008) for WiMAX and 3GPP systems can be used as the access network discovery and selection function (ANDSF). TAVH protocol performs horizontal or vertical handoff accordance by the information of ANDSF in neighbor discovery unit since it can learn the details of neighboring BSs including IP address in order to decide which kind of handoff should be performed by TAVH protocol.

**Handoff signaling delay estimation unit:** The handoff signaling delay is the time taken for the whole handoff process. How long the time taken greatly depends on which kind of handoff type: horizontal handoff or vertical handoff. On the other hand, it greatly depends on the third part of handoff process. We use the protocol PMIPv-6 to estimate handoff signaling delay for handoff process. Firstly, mobility access gateway (MAG) of UE

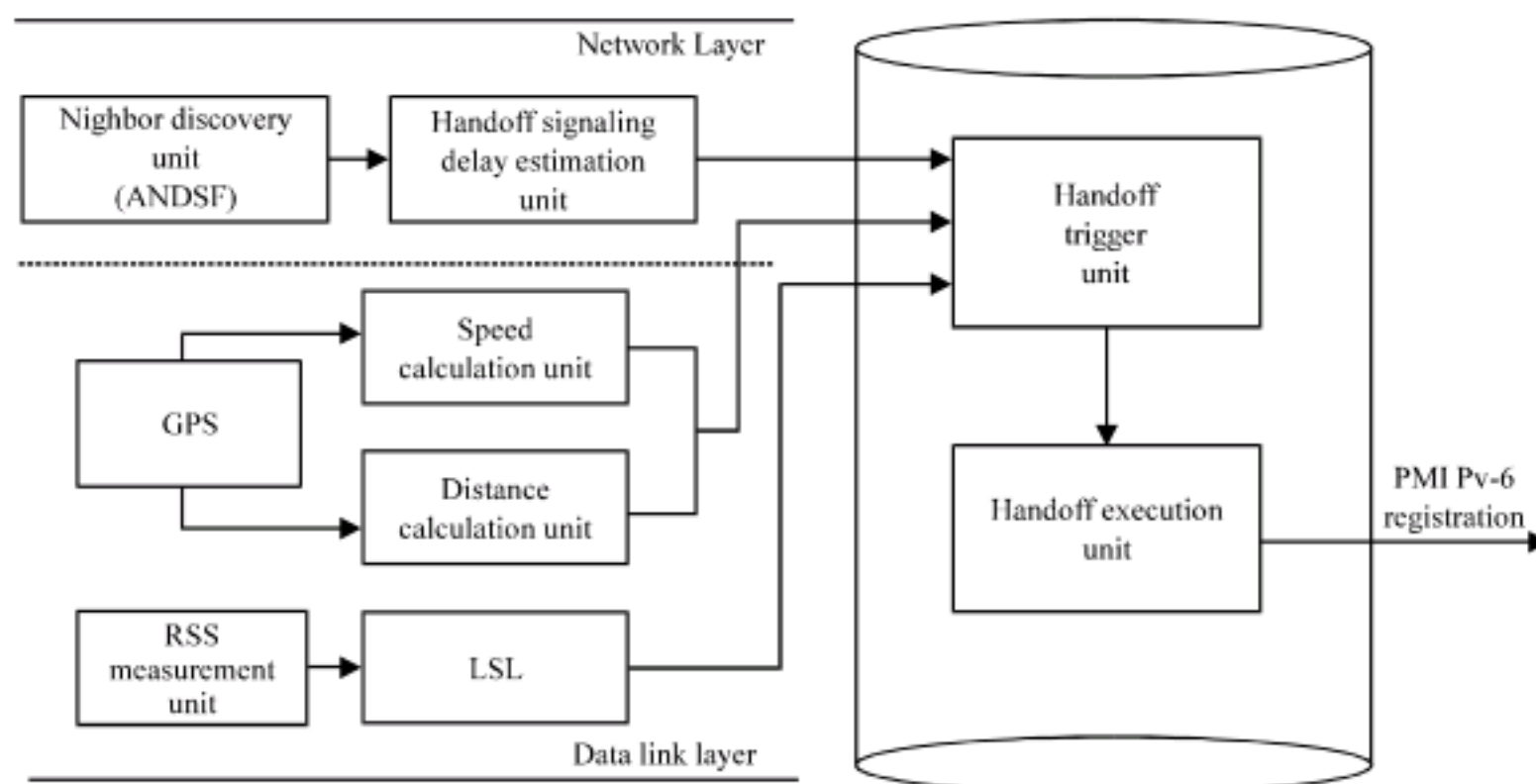

Fig. 3: Module of trajectory-aware vertical handoff management architecture

sends binding update message to LMA to inform its current address. Then, LMA creates the Binding Cache entry as well as sets up bi-directional tunnel to the mobile access gateway before acknowledgment message. After the MAG has received acknowledgment message, it also serves necessary mobility functions. Then, MAG sends router advertisement messages to the mobile node and hence packets transmission can be done through by MAG since it already has necessary information including home network prefix (es). PMIPv-6 protocol signaling delay estimation unit counts the time taken during whole handoff process. Since PMIPv-6 handles mobility management by Mobile Access Gateway (MAG) and Local Mobility Anchor LMA, packets sent by an MN should traverse the MN's MAG as well as LMA and hence it introduces some delay. So, handoff signaling delay time can not be same for any type of applications as well as it can not be constant for all. But, here, we assign handoff signaling delay to a constant value based on the requirement of the type of service which we are using.

**Handoff initiation:** While UE moves between the networks, it learns neighbor cells so that handoff decision

can be made in correct timing. When handoff decision is made, UE can do alone without assistance of network as well as with assistance of network since there is available information about neighbor cells generated by neighbor discovery unit. Thus, even though UE is currently serviced by a 3GPP cell, it can correctly switch once WiMAX service becomes available. When UE needs to switch from 3GPP to WiMAX or from WiMAX to 3GPP, it is crucial to decide the right time when it should initiate handoff. Proposed TAVH protocol makes handoff decision based on two conditions: location and received signal strength of MT. Handoff trigger unit uses radial velocity information and location information generated from GPS or A-GPS (Kaplan and Hegarty, 2006) and handoff signaling delay so that adaptive distance threshold can be calculated. Another condition for handoff decision is, of course, RSS of MT. Here, RSS of MT is applied by least square line (LSL) firstly in order to take advantages which can avoid unnecessary handoffs or Ping-Pong handoffs. Accordance by this information, handoff trigger unit in TAVH protocol can decide precise time when handoff should initiate. The detail processing

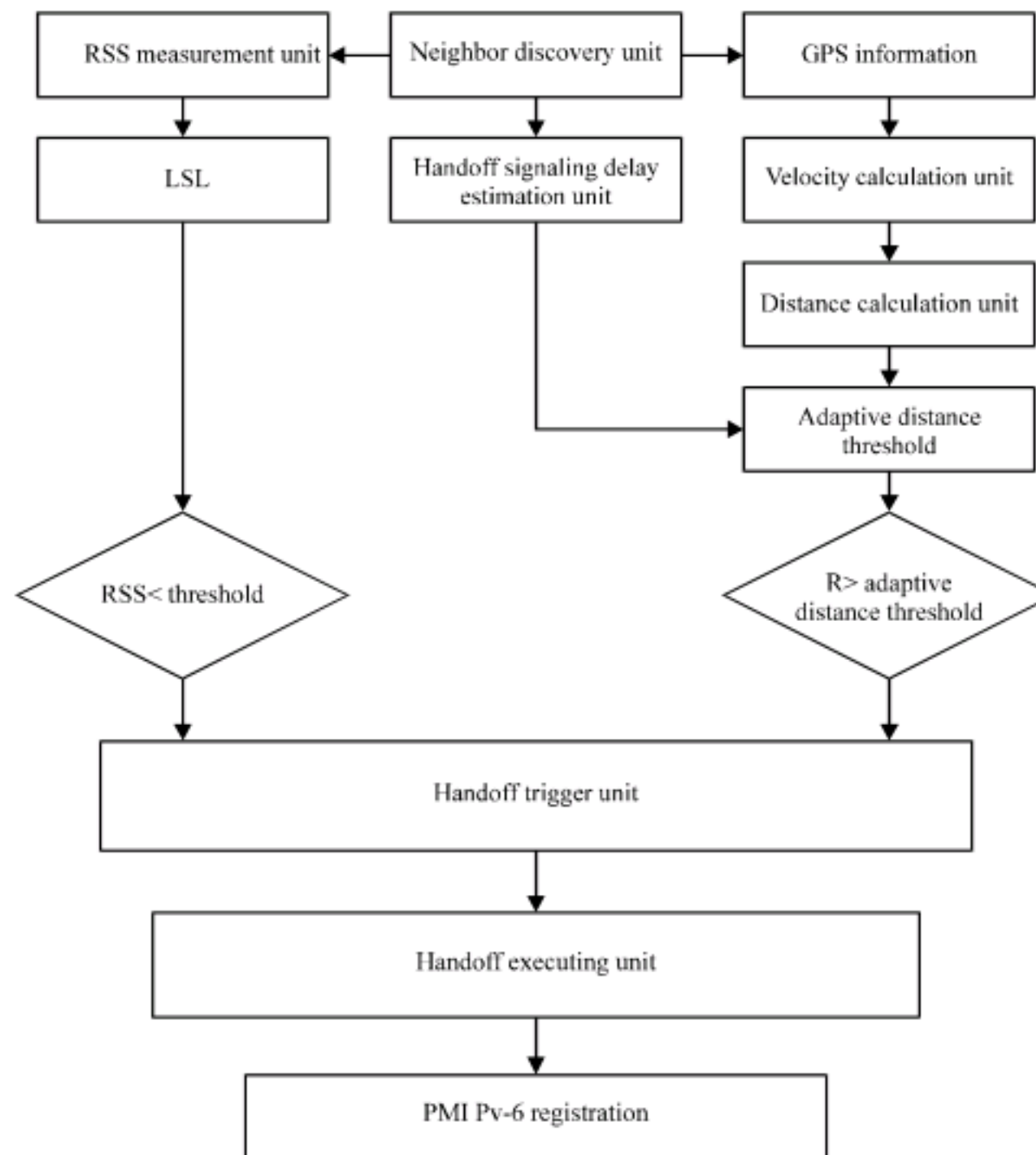

Fig. 4: Flow chart of trajectory-aware vertical handoff protocol operation

of handoff initiation is referenced to (Thazinei and Furong, 2009). Once handoff trigger unit sends a trigger to handoff executing unit, it starts PMIPv-6 registration. The operation flow chart of TAVH protocol is demonstrated in Fig. 4.

**Handoff execution unit:** Once handoff executing unit receives the handoff trigger, it can be known that the

signaling call flow can not be supported longer by the previously attached mobile access gateway (p-MAG) and hence it needs to switch the newly attached mobile access gateway (n-MAG). So, p-MAG serves MN detached event so that MN can attach with n-MAG. Once MN has attached with n-MAG, n-MAG initiates registration procedures. Firstly, MN binds its new current address to the local mobility anchor (LMA) by sending Proxy

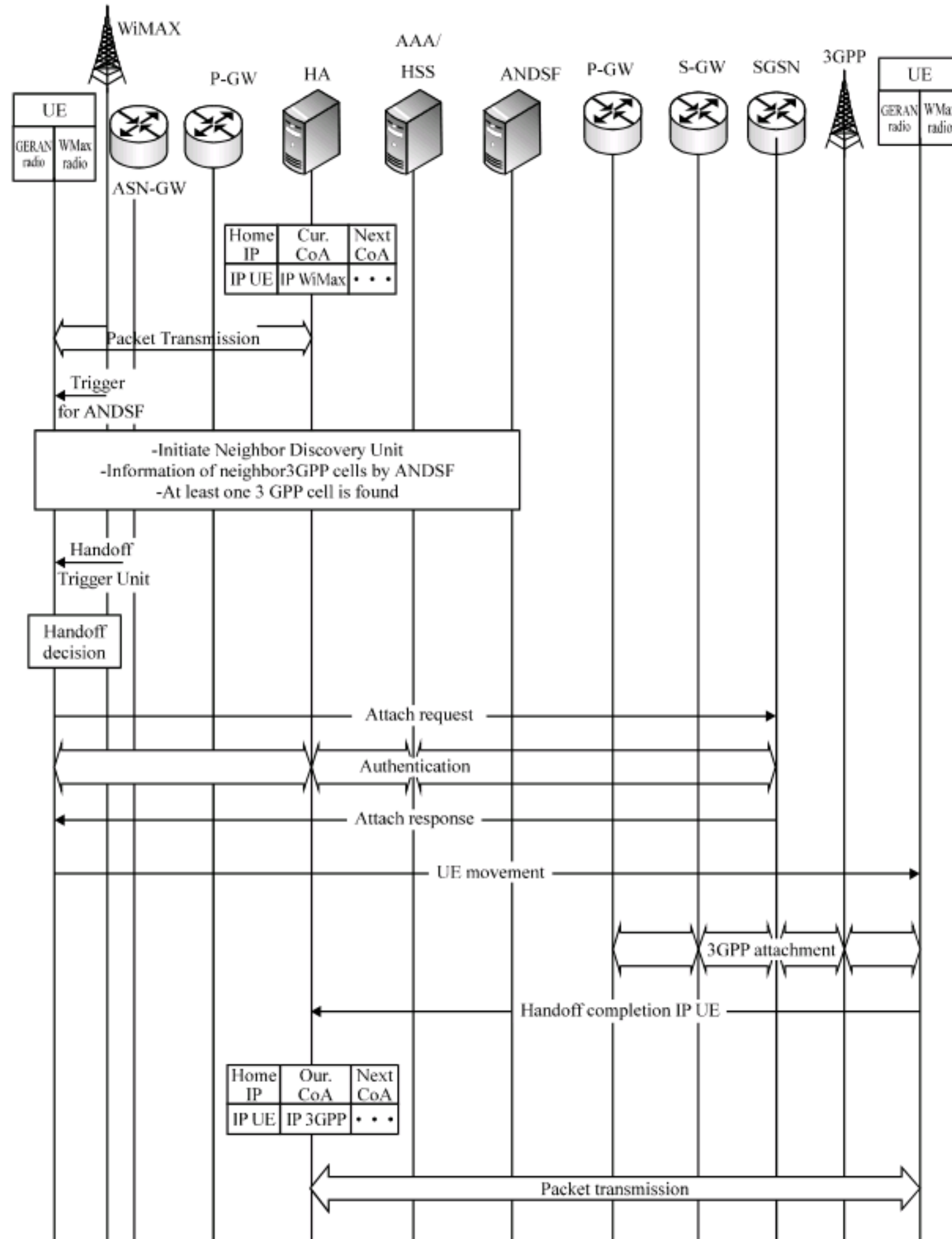

Fig. 5: Handoff procedures when MT moves from WiMAX to 3GPP access

Binding Update message. When this message is accepted by LMA, it not only creates the Binding Cache entry, but also sets up its endpoint of the bi-directional tunnel to the mobile access gateway. Then, it sends back the Proxy Binding Acknowledgment message to the n-MAG so that it can set up its endpoint of the bi-directional tunnel to the local mobility anchor as well as the forwarding for the mobile node's traffic. Now, n-MAG can send Router Advertisement messages to the mobile node since it has all required information with home network prefix (es) of the MN. Once MN has received that advertisement message, address configuration is done. Then, packets transmission is initiated. Detail processing procedures of handoff executing unit between WiMAX and 3GPP networks are described as the following.

**Handoff procedures when MT moves from WiMAX to 3GPP networks:** Figure 5, demonstrates the handoff procedures when MT moves from WiMAX to 3GPP networks. As demonstrated in figure, UE is supported with two interfaces for WiMAX access and 3GPP access (here, we refer GERAN radio interface for 3GPP accesses) and PMIPv-6 has been supported for mobility management between networks through by access routers, gateways. Firstly, UE is serviced by WiMax access through the gate way P-GW. The UE finds an ANDSF in the neighbor discovery unit so that information about all of neighbor 3GPP networks can be downloaded to perform handoff one network of 3GPP networks. Once ANDSF is initiated, UE gets information which the target network is for handoff. Then, UE receives handoff trigger sent from handoff triggering unit in order to start handoff executing processing. UE sends attach request message to Serving GPRS Support Node (SGSN) through by PDN Gateway (P-GW), Serving Gateway (S-GW) and it authenticates itself with AAA/HSS server accordance by selected 3GPP network's authentication procedures (here, GERAN authentication procedures) so that it can attach with 3GPP network. After the successful authentication, UE receives back attachment response message which informs it that the servicing of 3GPP can be accessed starting from now. Then, MT allocates its current address issued by the FA from GGSN in visited network with HA. After that, UE registers this current address to HA by sending binding update message. When it receives back binding acknowledgment message from HA, it can communicate with corresponding node (CN) through the HA by Proxy MIPv6 tunneling. The packets destined to CN are transmitted by PMIPv-6 tunneling.

**Handoff procedures when MT moves from 3GPP to WiMAX:** The procedures for reverse handover from 3GPP

to WiMAX networks are demonstrated in Fig. 6. Here, UE is currently supported by 3GPP access (GERAN radio interface) and PMIPv-6 is a mobility management protocol for UE's roaming between networks. The UE finds ANDSF from neighbor discovery unit since UE needs the information of neighbor cells in order to know whether WiMAX services are becoming available. Then, UE found all neighbor cells data and one WiMAX base station is available. Once UE receives the handoff trigger delivered from handoff triggering unit, handoff is decided to initiate at that time. Thus, handoff executing unit starts Proxy MIPv-6 registration to process handoff from 3GPP to WiMAX network. UE sends attach request message to P-GW which WiMAX base station is anchored through PDN Gateway (P-GW). Then, UE authenticates itself with AAA/HSS server accordance by WiMAX authentication procedures, on the other hand, by processing EAP framework so that it can access with WiMAX service. After the successful authentication, P-GW sends attachment response message to UE in order to enjoy WiMAX service starting from this time. Then, MT allocates its current address issued by ASN-GW in visited network to HA. After that, UE registers this current address to HA by sending binding update message. When it receives back binding acknowledgment message from HA, it can communicate with corresponding node (CN) through the HA by Proxy MIPv6 tunneling. The packets destined to CN are transmitted by PMIPv-6 tunneling.

## **SIMULATION, PERFORMANCE ANALYSIS AND COMPARISON OF TAVH**

An extensive, practical and real-time simulation is carried out to analyze the performance of TAVH and to compare its performance to those of other handoff methods. This analysis comprises of the following parts: simulation model overview, simulation parameters and initial assignments, output parameters, description of handoff methods being compared and analyzed, simulation results and analysis of simulation results.

**Simulation model overview:** The simulation engine used in for this analysis is MATLAB (Version 7.1). MATLAB is a high-level technical computing language and interactive environment for algorithm development, data visualization, data analysis and numeric computation. The simulation model includes a 3GPP Base Station at the centre of the simulation space and four WiMAX base stations inside its range as shown in Fig. 7.

The range of the 3GPP BS in this simulation is assumed to have 2.4 km radius and the range of each WiMAX AP is 1 km in radius. Here, WiMAX is assumed



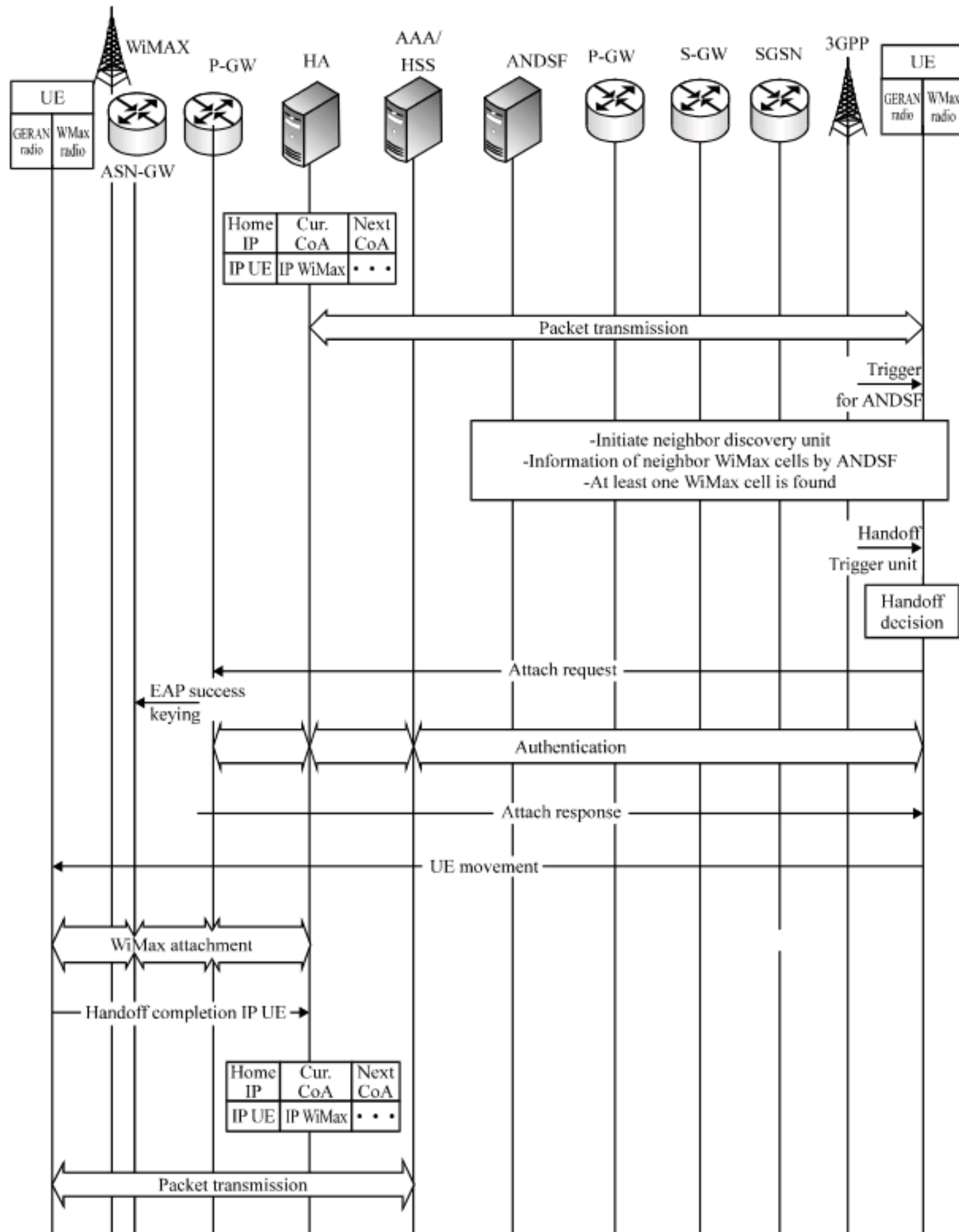

Fig. 6: Handoff procedures when MT moves from 3GPP to WiMAX

to be the user-preferred service, because it will be more cost efficient and provide better bandwidth. Four mobile terminals (or mobile nodes), each with different handoff algorithms, are then assumed to move in a random motion model. The MTs will move together as a group inside a predefined rectangular range. The purpose of MTs moving together in this way is so that they will share the same trajectory, which provides better relevance in comparison of the performance of each algorithm.

The random motion model used in this simulation model is very realistic. The mobiles move with random velocity (random magnitude and random direction) which is updated in every 1 min. The magnitude of the velocity varies inside the range from 0 to 30 m sec<sup>-1</sup>. The direction of the velocity may also be anything between 0 to 360°. When the MTs get to the boundary of the predefined rectangular range, they will change their velocity (both magnitude and direction) randomly to get back inside the range. The predefined rectangular range covers all the BS

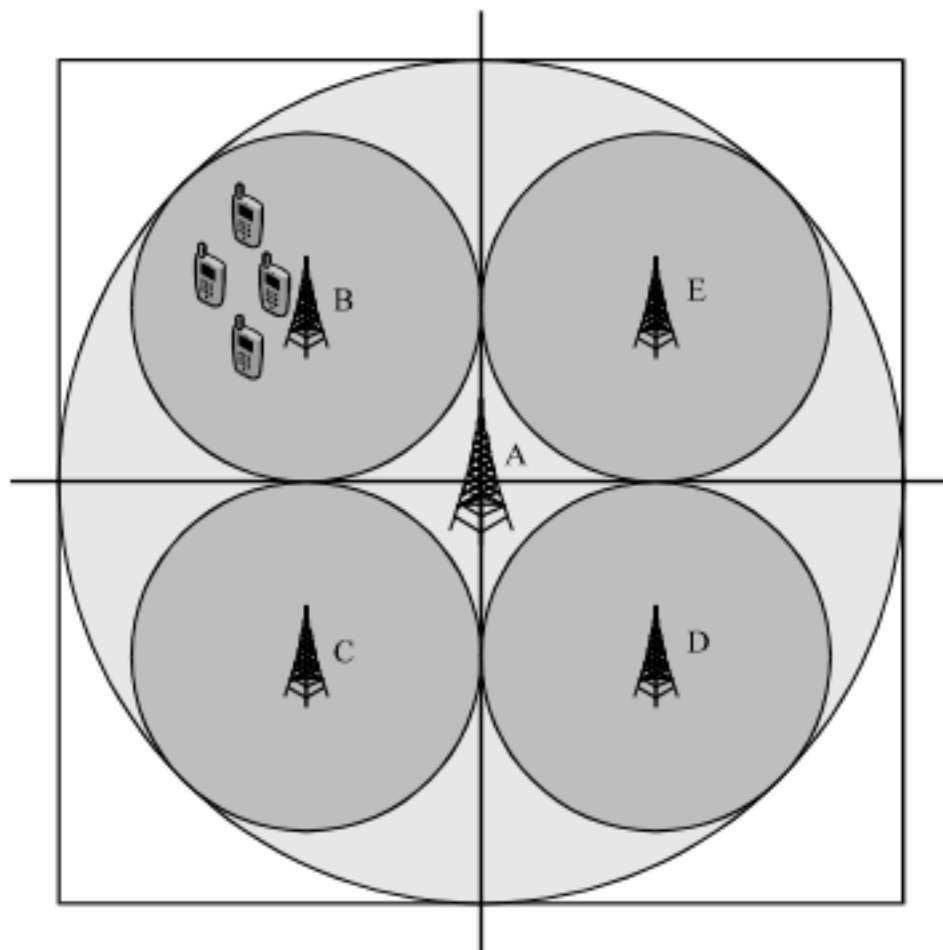

Fig. 7: Simulation model

and APs. Moreover, it even includes areas where no service is available.

The path-loss and shadowing is used to calculate the RSS of MTs. This model can be described mathematically as:

$$RSS = PL(d_0) - 10n \log_{10}\left(\frac{d}{d_0}\right) + \delta \quad (1)$$

Where:

PL ( $d_0$ ): The received power at a reference distance ( $d_0$ )

n : The path loss exponent,  $d$ =the distance between base station and MT

$\delta$  : The zero-mean Gaussian random variable

For all BSs, PL is assumed to be -30 dB and  $d_0$  is assumed to be 10% of the range diameter of Bss.

For the simulation to be more realistic, the additive white Gaussian noise (AWGN) with standard variation of 8 dB is added to the RSS computation. The RSS of each MT is measured after every interval of sampling time, which is 1 sec in this simulation. Each simulation is carried out for a runtime of 7200 sec (2 h). To acquire the consistency and reliability in output data, such 2 h long simulations are carried out for 5 times. Therefore, total simulation time for this simulation is 10 h.

#### Simulation parameters and initial assignments

**Handoff delay:** Handoff delay is the time elapsed during the process of handoff in MT when it roams from one service to another. For simplicity of this simulation,

handoff delay is assumed to be 5 sec for all kind of handoffs, including both 3GPP to WiMAX handoff and WiMAX to 3GPP handoff.

**Handoff failure:** Handoff failure occurs when the MT lost the service from one station while the handoff process is not yet finished. When this happens, MT is connected back to 3GPP BS, on condition that it is still in the service range of the 3GPP BS, after a 10 sec delay. Handoff failures cause undesired interruptions in communication.

**False handoff:** False handoff is defined as the handoff which occurs earlier than the necessity. Premature handoffs degrade the efficiency and utilization of the communication channels and increase the signaling workload.

**Ping-pong handoff:** When handoffs occur back and forth between two services within a small specific time, the performance of the communication system is severely affected by the resultant signaling processes. Such kind of handoffs is hereby described as ping-pong handoffs. In this simulation, when handoff between the same two services occurs more than once in 8 sec interval, it is determined as a ping-pong handoff.

**Package delivery:** In this simulation, it is assumed that the 3GPP BS provides the MT with a bandwidth of 144 kbps, while the MT is moving at vehicular velocity. On the other hand, the bandwidth of WiMAX is assumed to be 11 Mbps, according to IEEE 802.11 b standards. It is considered that an application is transmitting and receiving packages with size of 400 bytes. With 3GPP service, the application will be transmitting/receiving 2 packages per second, while on the other hand, with WiMAX service, it will be transmitting/receiving 10 packages per seconds, both in uplink and downlink. After encountering a handoff and acquiring a new service, the application will wait for 3 sec delay and will start transmitting/receiving packages.

**Output parameters:** The following parameters are recorded as output of each simulation, number of handoff failures, number of false handoffs, number of ping-pong handoffs, the time for which the MT was being served by each of the 3GPP and WiMAX and total number of packages sent and received by each of 3GPP and WiMAX. From these output data provided by the simulation, the following parameters are calculated.

- Percentage of the time the MT is being served by 3GPP over total simulation time

- Percentage of the time the MT is being served by WiMAX over total simulation time
- Overall Package Delivery Ratio (PDR) during the simulation time
- Overall throughput during the simulation time

Overall Package Delivery Ratio (PDR) during the simulation time. The PDR is defined as the percentage of packets received over total packets sent.

$$\text{PDR} = \{\text{No. of packets received}/\text{No. of packets sent}\} \times 100 \text{ (percentage)}$$

Overall throughput during the simulation time. Throughput is defined as the amount of data received during a unit time.

$$\text{Throughput} = \text{No. of bits received}/\text{total simulation time (bps)}$$

**Description of handoff methods being compared and analyzed:** In this simulation, there are four handoff methods which performance will be compared and analyzed:

- Normal Hysteresis Method
- Adaptive Hysteresis Method
- Hysteresis Plus Dwelling Timer Method and
- Proposed TAVH method

**Normal hysteresis method:** In this method, handoff is performed whenever the RSS of new BS is higher than the RSS of old BS by a predefined value (Zhang and Holtzman, 1996; Marichamy *et al.*, 2003). In pseudo codes:

```
if (RSSnew - RSSold) > hys
    handoff;
end
```

In this simulation, the hysteresis value is assumed to be 10 dB.

**Adaptive hysteresis method:** This method is basically similar to normal hysteresis method. However, in this method the hysteresis value is not fixed as in the normal hysteresis method (Lal and Panwar, 2007; Zhu and Kyung-Sup, 2007). The hysteresis value is varying according to the distance of MT from the BS. The hysteresis value is calculated as:

$$h = \max \left\{ 20 \left( 1 - \left( \frac{d_i}{R} \right)^4 \right), 0 \right\} \quad (2)$$

where,  $d_i$  is the distance between serving BS and MT,  $R$  is the radius of serving cell.

**Hysteresis plus dwelling timer method:** In this method, whenever the RSS of new BS is higher than the RSS of old BS by a predefined hysteresis value, a timer is triggered. When this timer reached to certain specified value, handoff is processed. The dwelling timer is reset when the RSS of new BS is no longer higher than the RSS of old BS by the hysteresis value or when handoff is processed. Some references of using dwelling timer are (Pollini, 1996; Park *et al.*, 2003). In pseudo codes:

```
if (RSSnew - RSSold) > hys
    Timer ++ = sampling time;
else
    reset Timer;
end
if Timer > Dwelling Delay
    handoff;
    reset Timer;
end
```

In this simulation, the hysteresis value is assumed to be 10 dB and dwelling delay is assumed to be 3 sec.

**Proposed TAVH method:** In this method, the position, velocity and RSS of MT are calculated and each and every data is taken in account in handoff decision.

A handoff is carried out whenever the position of MT has reached to a certain boundary, regardless of the RSS. This reduces the rate of handoff failures. Here, the boundary is not the boundary of the range of the BS. The boundary is a safety distance of MT from the BS to assure a successful handoff and this boundary is not fixed and is varying according to the position and velocity of the MT.

On the other hand, handoff is also carried out whenever the RSS of MT has dropped below predefined threshold value (-60 dB in this simulation). Moreover, LSL method is applied to RSS values to ensure the avoidance of ping-pong handoffs. In pseudo codes:

```
if (Position_of_MT > safe_boundary) OR (RSS_LSL <
threshold)
    handoff;
end
```

**Analysis of simulation results:** From the output graphs (Fig. 8-14), it is very obvious that the proposed TAVH method provides longer service time, more efficient package delivery ratio and better throughput for each and every service BS. In more spectacular perspective, the proposed TAVH method also guarantees quality of service (QoS) in terms of precision in Handoff (Less

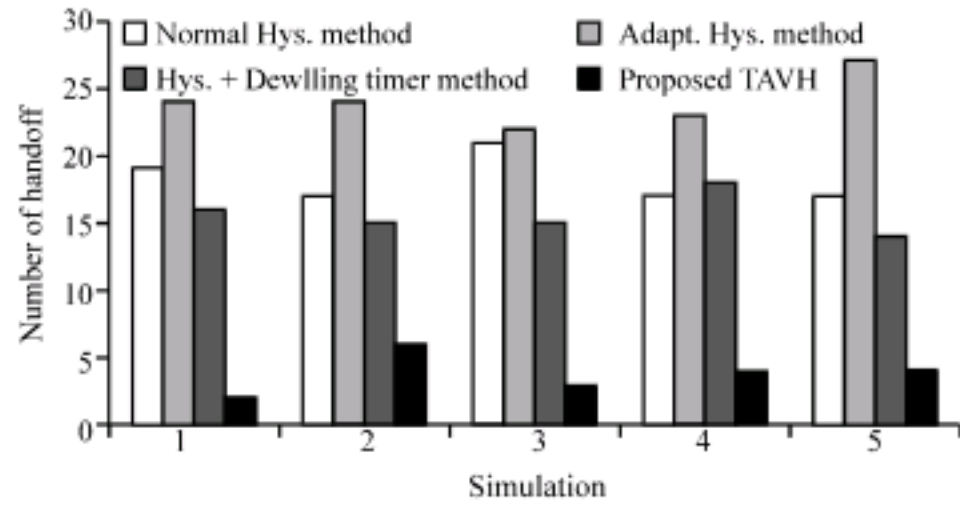

Fig. 8: Handoff failure for each method

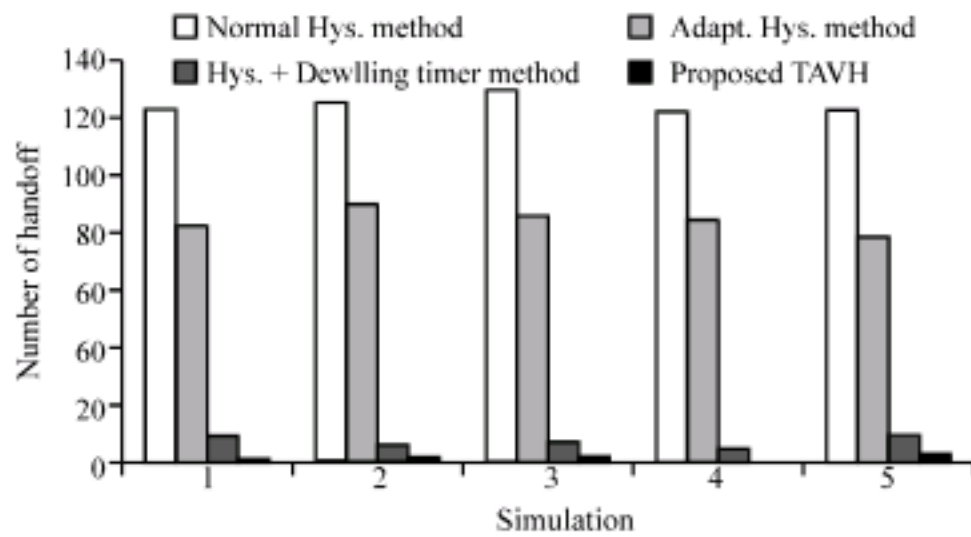

Fig. 9: False handoff for each method

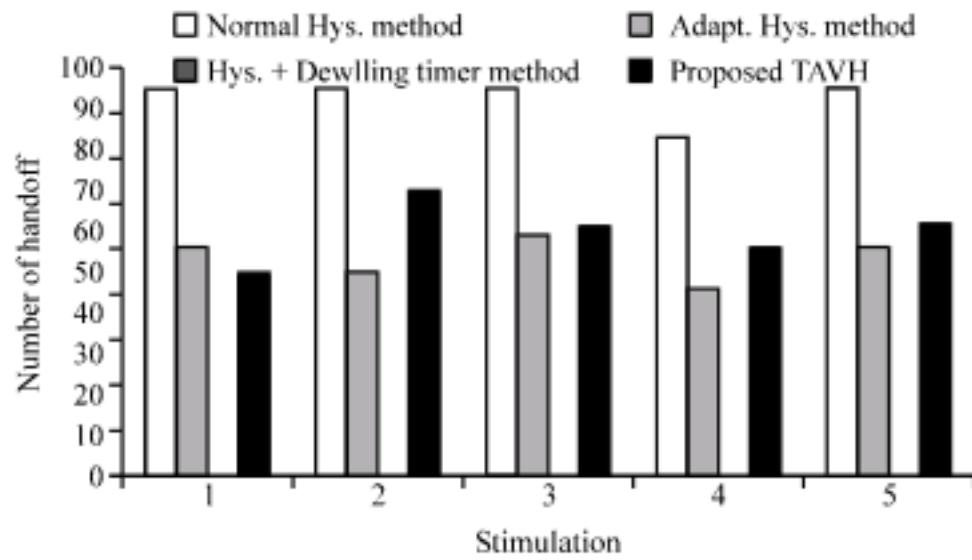

Fig. 10: Ping-pong handoff for each method

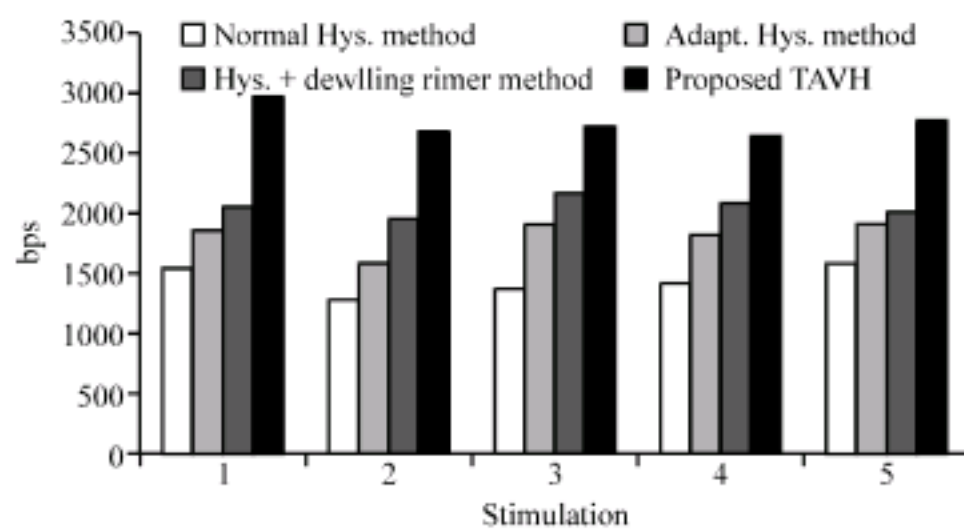

Fig. 11: Total average throughput for each method

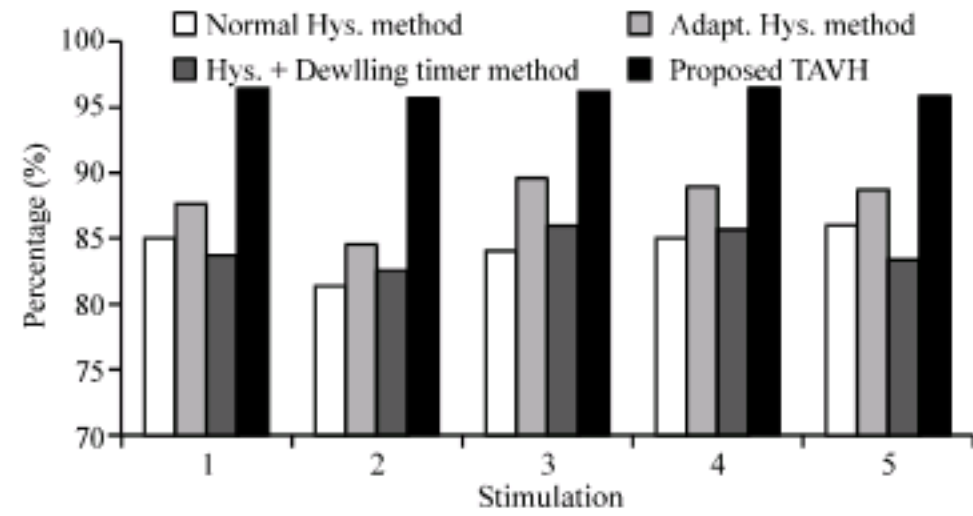

Fig. 12: Overall PDR for each method

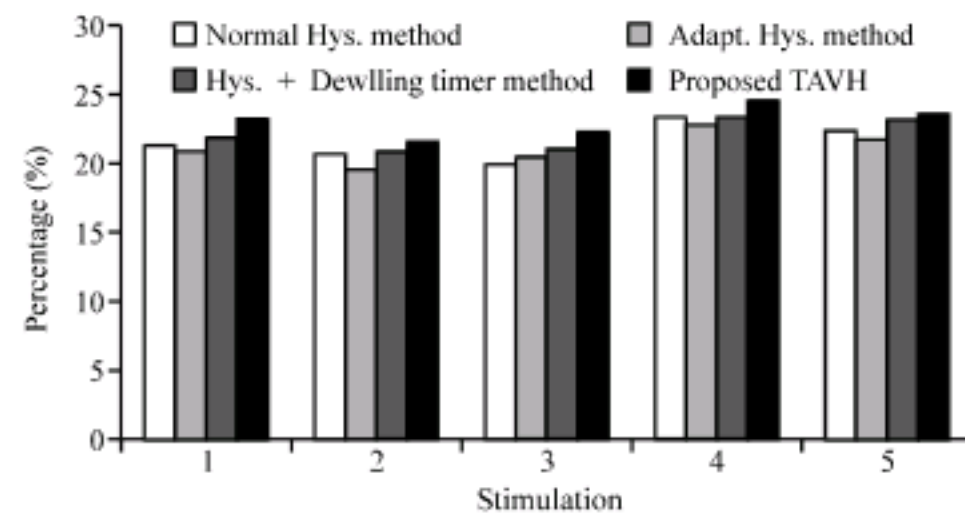

Fig. 13: Service time percentage of 3GPP for each method

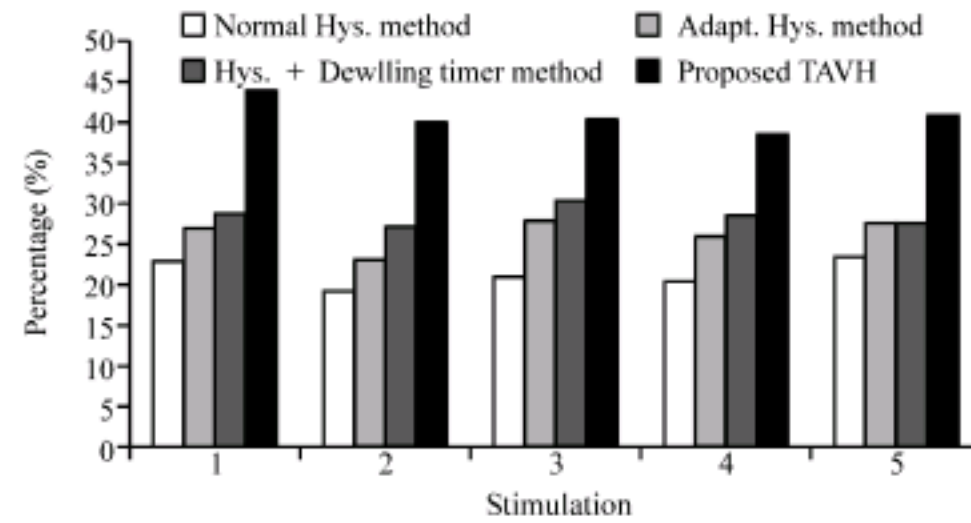

Fig. 14: Service time percentage of WiMAX for each method

handoff failure, less false handoff and less ping-pong handoff), longer total service time and longer user-preferred service time, better overall package delivery ratio and greater total throughput.

### CONCLUSION

It can be concluded that the proposed TAVH method consistently outperform the other methods in almost every output parameter of this simulation. Moreover, it should be noted that the performance of the proposed TAVH is not dependent too much on which RSS

threshold level being set, because it utilizes both trajectory information and RSS information of MT in handoff decision making. On the other hand, the performance of other methods substantially relies on the parameters such as hysteresis value and dwelling timer value. Lower hysteresis value will lead to more ping-pong handoff and higher hysteresis value will cause more handoff failures. The same concept also applies to the value of dwelling timer. Preset values of these parameters will not be suitable for all different kind of situations the MT is considered to encounter. Moreover, it is practically very difficult to measure the RSS values of both old BS and new BS at every sampling time. On the other hand the proposed TAVH method uses only the RSS value of old BS as part of the handoff decision, which is more realistic. Nowadays, the GPS technologies have become more and more cost-effective, abundant and efficient. Therefore, the proposed TAVH method is believed to be easily implemented and to accommodate wider range of powerful applications utilizing reliable and seamless wireless communications.

#### **ACKNOWLEDGMENTS**

This study was supported by the national natural science foundation of China under grant No.60572047 and by the program for New Century Excellent Talents in University, NCET-06-0642.

#### **REFERENCES**

- Bhattacharyal, P.P., S. Pall and R.N. Ghosh, 2008. Propagation environment and user velocity dependent fuzzy controlled call handoff for cellular systems. Proceedings of International Conference on Recent Advances in Microwave Theory and Applications, Nov. 21-24, IEEE Computer Society, Washington, DC, USA., pp: 331-333.
- Bing, H., C. He and L. Jang, 2003. Performance analysis of vertical handover in a UMTS-WLAN integrated network. Proceedings of the IEEE International Conference on Personal, Indoor and Mobile Radio Communications, Sept. 7-10, IEEE Computer Society, Washington, DC, USA., pp: 187-191.
- Cha, B., S.H. Seo, Y.M. Choi and J.S. Song, 2008. Mobile-velocity adaptive vertical handoff in integrated WLAN and wibro networks. Proceedings of 4th International Conference Information and Automation for Sustainability, Dec. 12-14, Computer Science University Seoul, pp: 384-389.
- Diab, A., A. Mitschele-Thiel, K. Getov and O. Blume, 2008. Analysis of proxy IPv6. Proceedings of 33rd IEEE Conference on Local Computer Networks, Oct. 14-17, University of Technology, pp: 579-580.
- Hui, T., Y. Ning, X. Huaiyao and Z. Ping, 2007. A handoff avoidance scheduling for elastic data in cellular transmission. Proceedings of International Conference on Wireless Communications, Networking and Mobile Computing, Sept. 21-25, IEEE Computer Society, Washington, DC, USA., pp: 1838-1840.
- Juang, R.T., H.P. Lin and D.B. Lin, 2005. An improved location-based handover algorithm for GSM systems. Proceedings of Wireless Communications and Networking Conference, Mar. 13-17, University of Technology Taiwan, pp: 1371-1376.
- Kaplan, E.D. and C.J. Hegarty, 2006. Understanding GPS: Principles and Applications. 2nd Edn., Artech House, Inc. USA., ISBN: 1-58053-894-2006.
- Kim, W.I., B.J. Lee, J.S. Song, Y.S. Shin and Y.J. Kim, 2007. Ping-pong avoidance algorithm for vertical handover in wireless overlay networks. Proceedings of the IEEE 66th Vehicular Technology Conference, Sept. 30-Oct. 3, Baltimore, MD, pp: 1509-1512.
- Kim, D., M. Sawhney and N. Kim, 2008. A velocity-based bicasting handover scheme for 4G mobile systems. Proceedings of Wireless Communications and Mobile Computing Conference, Aug. 6-8, IEEE Computer Society, Washington, DC, USA., pp: 147-152.
- Lal, S. and D.K. Panwar, 2007. Analysis of handoff algorithm with adaptive hysteresis margin. Proceedings of 10th International Conference on Information Technology, Dec. 17-20, IEEE Computer Society, Washington, DC, USA., pp: 133-138.
- Lin, H.P., R.T. Juang and D.B. Lin, 2005. Validation of an improved location based handover algorithm using GSM measurement data. Proceedings of Transactions on Mobile Computing, Sept.-Oct., IEEE Computer Society, Washington, DC, USA., pp: 530-536.
- Liu, M., X. Guo and E. Dutkiewicz, 2008. Performance analysis and optimization of handoff algorithms in heterogeneous wireless networks. IEEE Trans. Mobile Comput., 7: 846-857.
- Marichamy, P., S. Chakrabarti and S.L. Maskara, 2003. Performance evaluation of handoff detection schemes. Proceedings of Conference on Convergent Technologies for the Asia-Pacific Region, Oct. 15-17, Kovilpatti India, pp: 643-646.
- Mohanty, S., 2005. A novel velocity estimation algorithm for next-generation wireless systems. IEEE Trans. Wireless Commun., 4: 2655-2660.
- Park, H., S. Yoon, T. Kim, J. Park, M. Do and J. Lee, 2003. Vertical Handoff Procedure and Algorithm Between IEEE802.11 WLAN and CDMA Cellular Network. Springer, USA., pp: 103-112.

- Pollini, G.P., 1996. Trends in handover design. Proceedings of Communications Magazine, March 1996, IEEE Computer Society, Washington DC. USA., pp: 82-90.
- Thazinei and W. Furong, 2009. A trajectory-aware vertical handoff algorithm. Proceedings of 17th International Conference on Software, Telecommunications and Computer Networks (SoftCOM), Sept. 24-26, IEEE, 2009.
- Wang, S.S., A. Rajendran and M. Wylie-Green, 2001. Adaptive handoff method using location information. Proceedings of the IEEE International Symposium on Personal, Indoor and Mobile Radio Communications, Sept. 30-Oct. 3, IEEE Computer Society, Washington, DC. USA., pp: 43-47.
- Xiao, C., K.D. Mann and J.C. Olivier, 2001. Mobile speed estimation for TDMA-based hierarchical cellular systems. Proc. Trans. Veh. Technol., 50: 981-991.
- Zhang, N. and J.M. Holtzman, 1996. Analysis of handoff algorithms using both absolute and relative measurements. IEEE Trans. Vehicular Technol., 45: 174-179.
- Zhang, Y. and C. Hsiao-Hwa, 2008. Mobile Wimax: Toward Broadband Wireless Metropolitan Area Networks. Auerbach Publications, Taylor, Francis Group, ISBN-10: 0-8493-2624-9.
- Zhu, H. and K. Kyung-Sup, 2007. Performance analysis of an adaptive handoff algorithm based on distance information. Comput. Commun., 30: 1278-1288.